



INTELLIGENT DEVICES FOR HANDLING



GROUP  
*Scaglia*  
1938

**INDEVA**<sup>®</sup>

INTELLIGENT DEVICES FOR HANDLING

# Scaglia Indeva

## A worldwide network at your service



### A reliable Company with a long history

The ant is a tireless and intelligent worker. It is able to lift and carry with ease loads much larger than itself. This simple analogy represents Scaglia Indeva's mission to design and produce industrial manipulators that are compact yet strong, simple yet intelligent, and offer improved performance whilst reducing the risk of injury and improving workforce wellbeing.

### A world-leading manufacturing company in the field of material handling and intra-logistics.

Since 1838 this family-owned company has been at the forefront of manufacturing and is now an important industrial group with diverse business interests worldwide.

Since 1970 Scaglia Indeva has been at the leading edge of design and manufacture of innovative, ergonomically designed industrial manipulators that are used by major global manufacturers in varied applications throughout the world.

**World-wide, Scaglia Indeva** works with many blue-chip manufacturers across most sectors, including the leading automotive companies, where innovative and reliable material handling solutions are required. Our headquarters are in Val Brembilla - Italy. Our key locations offer a central sales and support operation, which provides excellent engineering services and supply of spare parts.



HEADQUARTERS & PRODUCTION UNIT

ITALY



GERMANY



FRANCE



UNITED STATES



P.R. OF CHINA



UNITED KINGDOM



SWEDEN



## References

ABB  
 AIRBUS  
 AKZO FIBERS  
 APRILIA  
 ARCELOR MITTAL  
 AUDI  
 B.P. CHEMICALS  
 BANK OF ENGLAND  
 BANQUE DE FRANCE  
 BARILLA  
 BEKAERT  
 BENTELER  
 BENTLEY  
 BMW  
 BORG WARNER  
 BOSCH  
 BREMBO  
 BRIDGESTONE FIRESTONE  
 BRITISH AMERICAN TOBACCO  
 CATERPILLAR  
 CHRYSLER  
 CIBA GEIGY  
 CITROËN  
 COCA COLA  
 COMAU  
 CONTINENTAL  
 CPM-DÜRR GROUP  
 DAIKIN



DAIMLER  
 DENSO  
 DUCATI  
 DUNLOP  
 ELECTROLUX  
 ENICHEM  
 FAURECIA  
 FCA  
 FERRARI  
 FERRERO  
 FIAT  
 FINMECCANICA  
 FORD  
 FRESENIUS  
 GE AUTOMATION  
 GE AVIATION

GENERAL ELECTRIC  
 GENERAL MOTORS  
 GLAXO  
 GOODYEAR  
 ITALTEL  
 IVECO  
 JAGUAR LAND ROVER  
 JOHN DEERE  
 JOHNSON & JOHNSON  
 JSB  
 KELLOGGS  
 KIMBERLY CLARK  
 KRAFT GENERAL FOODS  
 KUKA  
 LAMBORGHINI  
 LEAR  
 LEONARDO HELICOPTERS  
 MAGNA WERKZEUGTECHNIK  
 MAHLE  
 MAN ROLAND DRUCKMASCHINEN  
 MERCEDES BENZ  
 MICHELIN  
 MOËT & CHANDON  
 NESTLE'  
 NISSAN  
 OPEL  
 PEPSICO  
 PERFETTI

PEUGEOT  
 PHILIP MORRIS  
 PIAGGIO  
 PIRELLI  
 PPG  
 PROCTER & GAMBLE  
 PSA  
 RENAULT  
 REYNOLDS TOBACCO  
 ROLLS-ROYCE  
 SAAB  
 SAINT GOBAIN  
 SCANIA  
 SCHNEIDER ELECTRIC  
 SIEMENS  
 STILL  
 TENARIS  
 THYSSEN  
 TOGG  
 TOYOTA  
 UNIFI  
 UNIROYAL  
 VALEO  
 VOLKSWAGEN  
 VOLVO  
 WHIRLPOOL  
 ZF



# Scaglia Indeva

## Intelligent Material Handling Technology

The **Liftronic® Series, known as INDEVA®** is a new generation of advanced industrial manipulators featuring electronic control. They represent the evolution from traditional manipulators and are part of the innovative product group of load handling devices known as **Intelligent Assist Devices**.

This series is equipped with an **advanced electronic control system** which overcomes the control limitations of pneumatic manipulators. They provide truly ergonomic and effortless handling.

The INDEVA® Liftronic® series offers numerous **important and unique advantages over a traditional pneumatic manipulator**, especially the **auto-weight sense and auto balancing** features:

- **Higher productivity:** using an INDEVA®, output can be maintained throughout a full shift giving increased productivity and operator wellbeing.
- **Better ergonomics:** a fingertip-sensitive handle allows for the lifting or lowering of heavy loads by simply touching the handle with a finger. Very little human effort is required during any part of the lift, place and lower process.
- **Higher precision:** with considerably more speed and precision than a traditional pneumatic manipulator, an INDEVA® allows for unsurpassed precision, where the operator will intuitively work at the pace best suited to the task. The operator has exceptional control with the lightest of touch needed.
- **User friendly:** the **auto weight sensing** and auto **balancing** functions operate in real time, so no need to pre-set the load or to keep buttons depressed. The **Float Mode** option allows the operator to control movement directly from the load.
- **Safety:** state-of-the-art safety features prevent movement unless an operator is present and in control. Should a power failure occur, the motor is held with a mechanical lock and the load cannot be released until power is restored, or the full weight of the load is supported.
- **Wireless connectivity for industry 4.0:** an INDEVA® can exchange data with the Customer IT System through the Company Network and allows visualisation of manipulator activity by means of interface software.
- **Remote trouble shooting:** an INDEVA® can be connected via Wi-Fi to **App Indeva**, so that machine data can be transferred to a remote tablet or smartphone in real time. This can assist fault diagnosis, so significantly reducing call-out charges and operator downtime.
- **Environment friendly:** low carbon foot print thanks to efficient and low energy consumption.

In applications which require speed of handling, smooth movement and precise load placement, the INDEVA's Liftronic® Series provide a perfect solution.



A recent case study by the Engineering Faculty of the Brescia University and published by the International Journal of Industrial Ergonomics, together with a comparison study carried out by the University of Milan proved how the use of an INDEVA® satisfies current industry demand for increased productivity combined with improved ergonomics and safety.

### EASY MAINTENANCE

Optimised modular structure with easy access to all components.

### Z AXIS CONTROL

It is possible to limit the stroke on the Z axis to suit the specific restrictions of each application.

### QUICK DIAGNOSTIC

Comprehensive auto - diagnostic software with clearly displayed error messages.

### TOUCH PANEL

User friendly and intuitive interface for the visualisation and setting of various operational parameters.

### FORCE SENSING HANDLE

It allows fingertip control providing immediate response to the operator's intention for up-down movements.

### STATE-OF-THE-ART SAFETY DEVICES

Electronic control allows for additional safety functions that cannot be incorporated in pneumatic manipulators.

### WIRELESS CONNECTIVITY AND REMOTE TROUBLE SHOOTING

Industry 4.0 ready.

### EASY TO UPGRADE

Designed to accept controls for your own gripping tools.

### ANTI-TANGLE- SWIVEL JOINT

Air and electrical connections are via a swivel joint on top of the tool head. This prevents the lift rope, power cable and air pipe becoming tangled if the process has continuous rotation in the same direction.

### FINE SPEED CONTROL

An INDEVA® moves at the pace best suited to the operator and application. This allows natural movement at all times, especially where precise placement is required. It is also possible to limit the lift and lower speed via the control panel.

### CAPACITY OVERLOAD

The maximum permitted lift can be preset to prevent system overload.

### FLOAT MODE

This control mode allows the operator to manipulate the load without direct contact with the controls.

### LOAD PLACEMENT PRECISION

The system allows very slow and controlled movements, so that a load can be precisely placed with no impact, so reducing the risk of damage.

# Scaglia Indeva

## Manipulators range

### Liftronic® Series

Intelligent Devices for Handling

#### Electronic control

The Liftronic® Series Intelligent Devices for Handling, known as INDEVA®, represent true evolution of traditional industrial manipulators.

State-of-the-art standardised components, combined with cutting-edge technology, hardware and optimised software provide a **high degree of safety and reliability.**

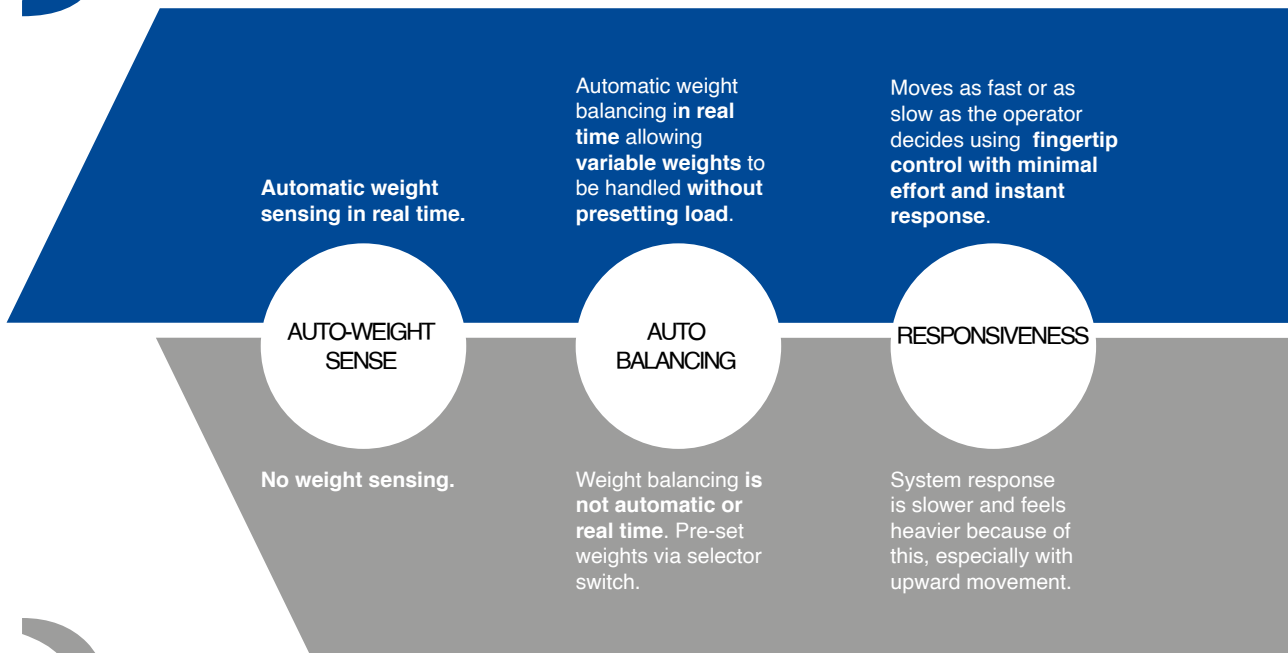
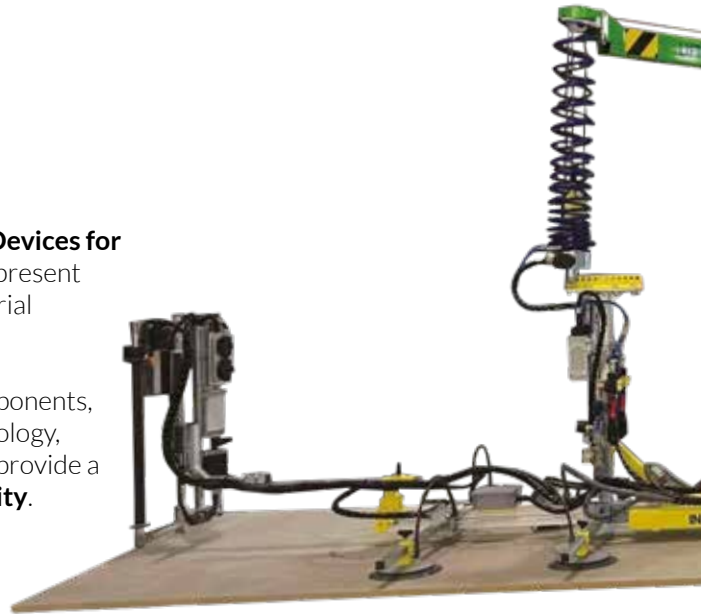

### PN Series

Traditional Industrial Manipulators

#### Pneumatic control

PN series manipulators are traditional industrial manipulators featuring pneumatic control and drive.

All manipulators in the PN Series can be designed in accordance with **ATEX regulations** as per EU Directives 2014/34 regarding applications in controlled environments with danger of explosion, classified classes 1 and 2 (Gas) (only for PN Flex) and 21 and 22 – Dust (for all PN series models).

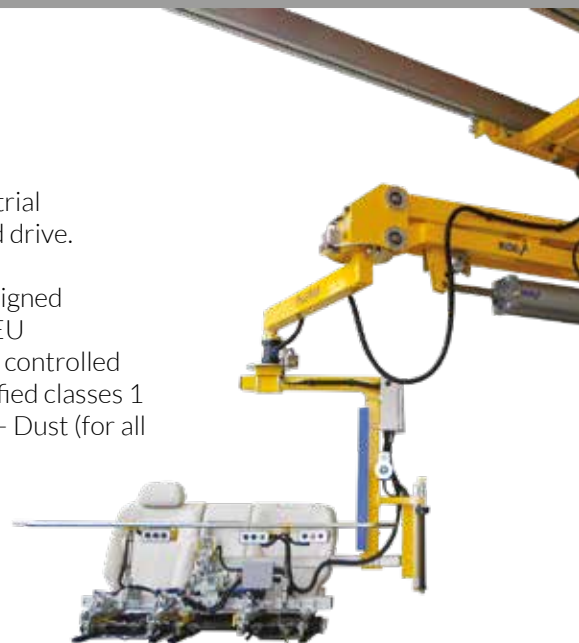



Rope

### Liftronic® Easy

Capacity up to 320kg.  
Suitable for **rapid and repetitive work cycles** with **simple gripping tools**.

### Liftronic® Pro

Capacity up to 320kg.  
Suitable for **complex work cycles** with **bespoke gripping systems**.



Rigid arm

### Liftronic® Air

Capacity up to 570kg.  
Suitable for handling **offset loads** with speed and precision.

**Precise and coordinated** with fine adjustment allowing accurate placement so reducing the risk of damage.

**Lower:** a comparative study showed that the CO<sup>2</sup> output and total running cost of an INDEVA® is around only 12,5% that of a pneumatic manipulator.

Light and compact structure allows **great visibility and ease of maneuverability**.

**Comprehensive auto - diagnostic software** and remote trouble shooting with App-Indeva or INDEVA® Gateway.

**Simple and efficient:** by means of display.

LOAD PLACEMENT

CARBON FOOTPRINT & TOTAL COST OF OPERATION

MANEUVERABILITY

DIAGNOSTIC & REMOTE TROUBLE SHOOTING

MAN / MACHINE INTERFACE

Some resistance is felt as air enters and leaves the cylinders so restricting natural speed of movement.

**Higher:** a comparative study showed that the CO<sup>2</sup> output and total running cost of a pneumatic manipulator is around 8 times that of an INDEVA®.

System requires heavier and bulkier structure so reducing visibility and maneuverability.

Check and diagnosis by expert technician attending site. Remote trouble shooting **is not available**.

**Restricted options** to identify faults at the machine.



Rope

### PN Flex

Capacity up to 160kg.

### PN Ergo

Capacity up to 570kg.  
Suitable for handling **offset loads**.

### PN Compatto

Capacity up to 100kg.  
Suitable for handling **offset loads in a small work area**.

### PN Zip

Capacity up to 80kg.  
Very compact structure suitable when a **short vertical stroke** is required.

Rigid arm

# Liftronic® Easy

## Intelligent Device for Handling

Liftronic® Easy is an INDEVA® - Intelligent Device for Handling. Suitable for rapid and repetitive work cycles with **simple gripping tools**.

### Main features

- Auto-weight sense and auto-balancing
- Can be integrated with App-Indeva and INDEVA® Gateway
- Unparalleled safety
- Ergonomic design
- Simple gripping devices
- Compact and light
- Fast, responsive and precise
- Low carbon footprint

### INDEVA® Gripping tools



### TECHNICAL DATA

**Max. gross capacity:** from 80 to 320kg  
(weight of lifting tool included)  
**Power supply:** 110/230 V-AC - 50/60 Hz  
**Power consumption:** max 700 VA  
**Enclosure protection:** 54 IP  
**Vertical stroke:** up to 2.80m





# INDEVA® Modulo

## Make your own gripping tool

Liftronic® Series

**INDEVA® Modulo is a standard component range for assembling a gripping tool which is to be attached to a Liftronic® Easy tool head.** It is easy for customers to design the tool to best suit their needs and then purchase the necessary parts. These standardised modules have been proven over many years and are a key part of our continuous improvement and development program.

### I-Connect



Standard I.O. Interface module: you can easily implement safety functions for your own custom gripping tool

### Gripping Modules

These chucks can be fitted with jaws according to your specific requirements



Scissor pantograph

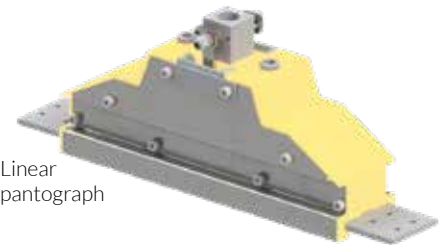

Linear pantograph



### Machine/Operator Interfaces



Remote controls



Remote touch sensitive handle available in different lengths

### Accessories



Air and electric connections via a continuous swivel joint at the toolhead to keep cables from tangling



Remote control handles complete with centre of gravity adjustment

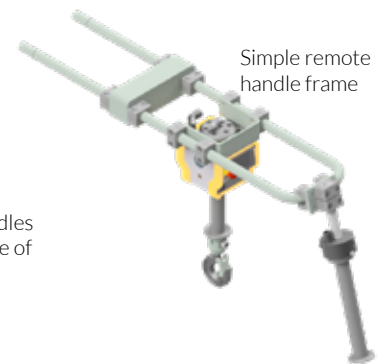

Simple remote handle frame



# Liftronic® Pro

## Intelligent Device for Handling

Liftronic® Pro is an INDEVA® - Intelligent Device for Handling. It is used for **complex applications with bespoke gripping systems**.

### Main features

- Auto-weight sense and auto-balancing
- Can be integrated with App-Indeva and INDEVA® Gateway
- Unparalleled safety
- Ergonomic design
- Bespoke gripping devices
- Compact and light
- Fast, responsive and precise
- Low carbon footprint



CUSTOMER IT SYSTEM

WI-FI COMPANY NETWORK

### INDEVA® Gripping tools



### TECHNICAL DATA

**Max. gross capacity:** from 80 to 320kg (weight of lifting tool included)  
**Power supply:** 110/230 V-AC - 50/60 Hz  
**Power consumption:** max 700 VA  
**Vertical stroke:** up to 2.80m

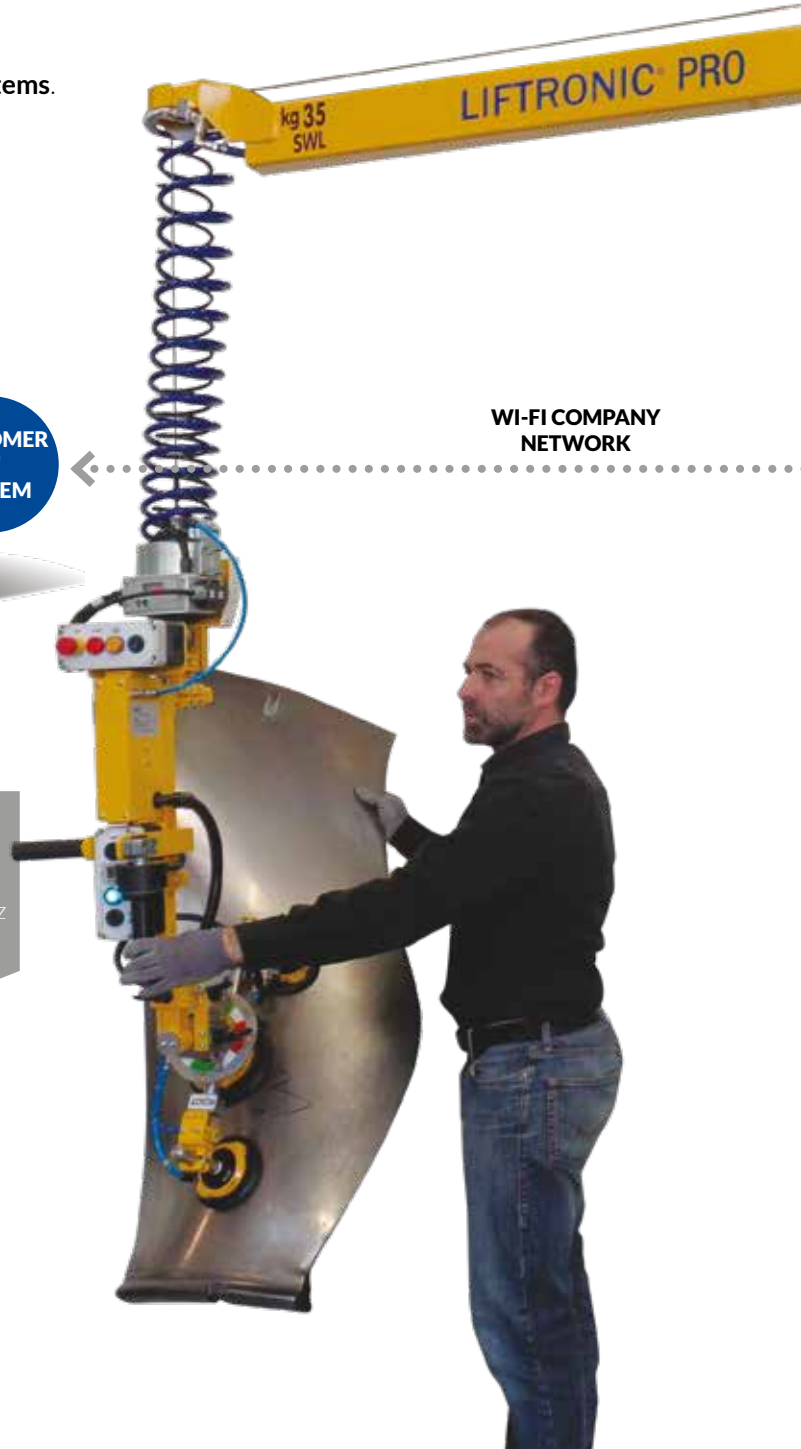

# Industry 4.0

## Wi-Fi Network Connectivity

Liftronic® Series

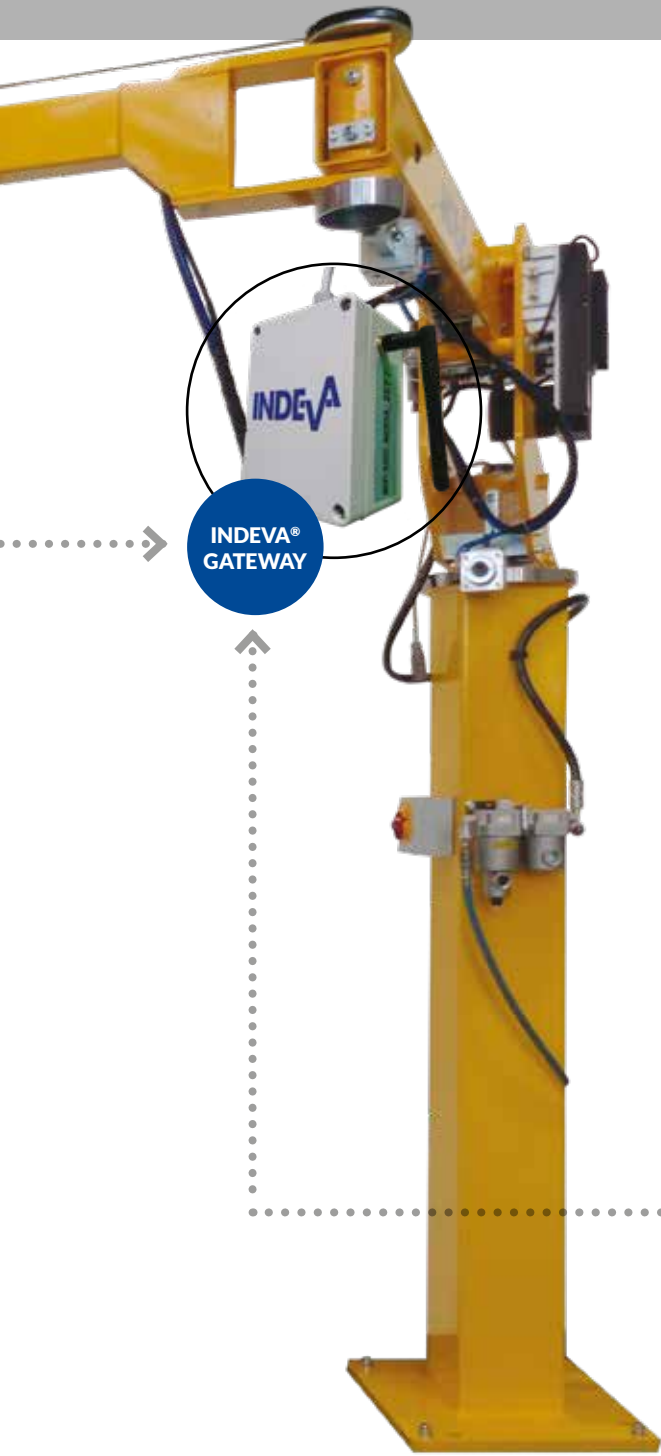

### Industry 4.0 ready

#### App-Indeva

Is a virtual INDEVA® service engineer always at disposal to the INDEVA® technician providing machine data capture and analysis, diagnostic and real time trouble shooting.

**App-Indeva**, is based on an in-house designed App suitable for Android smartphone or tablet that can be connected via Wi-Fi to the lift assistor, features **real-time capability to collect and analyse machine data** and deliver the results to the INDEVA® technician and to a **remote Indeva Service Centre**.

If you are using an INDEVA® manipulator equipped **with App-Indeva you will increase your machine availability time** through:

- *reduced time for diagnosis and trouble shooting by the INDEVA® technician*
- *reduced time for communication with an INDEVA® service centre*

#### INDEVA® Gateway

**Allows real time data exchange** with the Customer IT System through the Company Wi-Fi network and allows visualisation of production data by means of an interface software.

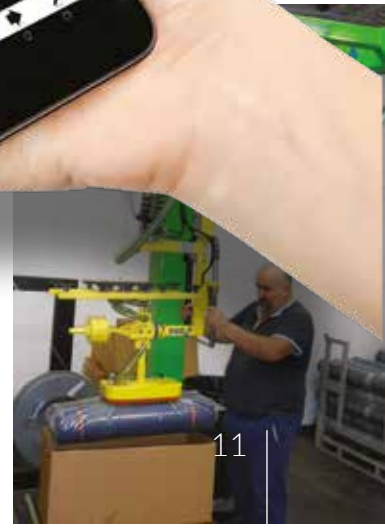

# Liftronic® Pro & Easy Versions

## Articulated Arms

### 2 JOINT ARMS

Standard arms featuring 2 joint articulation.

STRUCTURE	R1 (m)	2.5	3	3.5	4	4.5
L= Light	LC kg R2 (mm)	80 450	60 550	40 650	- -	- -
H= Heavy	LC kg R2 (mm)	260 630	190 760	140 880	105 1020	78 1140
X= Extra	LC kg R2 (mm)	- -	320 860	320 1005	280 1150	220 1300

LC= max load capacity; R2= dead area

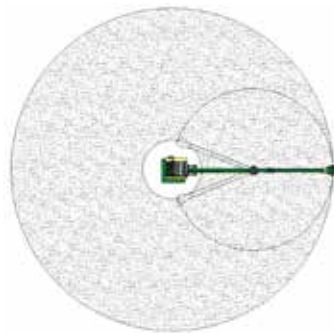
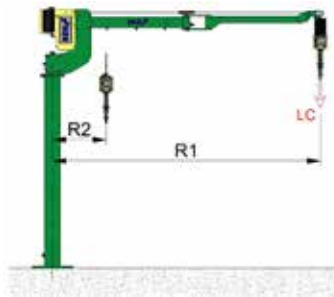

## Column + arm

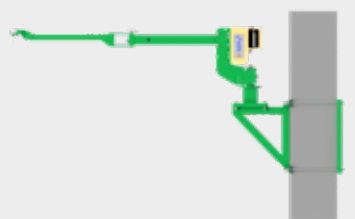

### 3 JOINT ARMS

The INDEVA® Orbit Arm3 is a 3 joint arm available on request for both column and overhead versions with capacities up to 145 kg (including tooling). The 3 joint Arm provides **increased coverage** within the radius of the arm and offers the operator smooth, controllable movement across the full radius with the added benefit of **quick sideways movement** using the forearm only.

STRUCTURE	R1 (m)	2.75	3.25	3.75	4.25	4.5
L= Light	LC kg R2 (mm)	- -	- -	- -	- -	- -
H= Heavy	LC kg R2 (mm)	145 250	105 250	80 250	55 250	45 250
X= Extra	LC kg R2 (mm)	- -	- -	- -	- -	- -

LC= max load capacity; R2= dead area

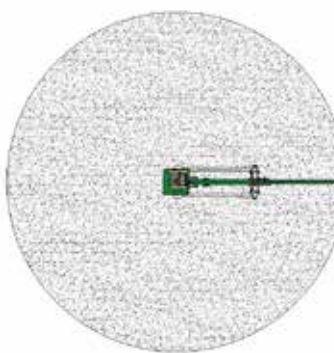
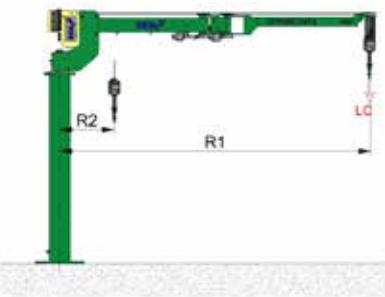

Overhead Arm



Fixed to ceiling

Liftruck

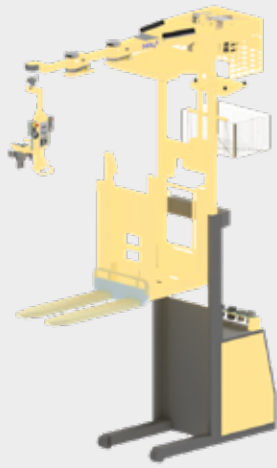

Order picker

Linear



Fixed to floor/base

Overhead rail

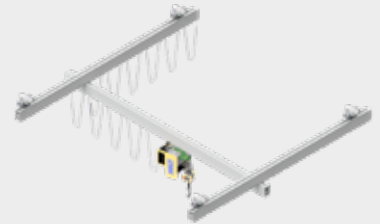

Bridge crane fixed to ceiling



Bridge crane column mounted

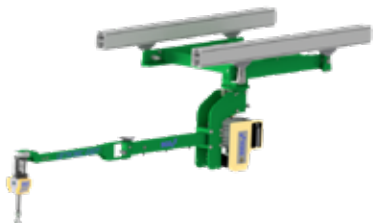

Underhung

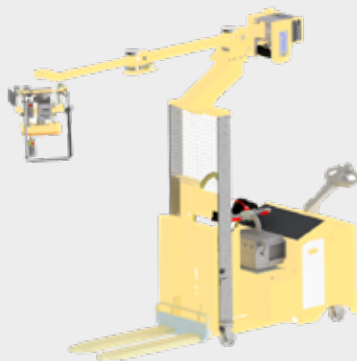

Transpallet



Underhung

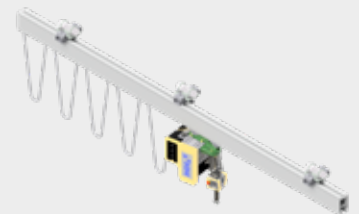

Monorail fixed to ceiling



# Liftronic® Air

## Intelligent Device for Handling

### Pneumatic drive - electronic control

The world's first manipulator with the strength of a traditional pneumatic manipulator and the intelligence of an INDEVA®.

It offers electronically controlled air and load management, delivering precise, energy efficient handling and auto weight sensing, removing the responsibility from the operator to make adjustments for different weights by utilising our touch sensitive handle technology.

It is suitable for handling offset and/or very heavy loads with minimum effort.

Liftronic® Air units can be supplied either column, ceiling or overhead rail mounted.

Compared to traditional pneumatically controlled manipulators, Liftronic® Air offers important advantages which help **improve safety, ergonomics, productivity and the Environment.**



### Main features

- Efficient use and delivery of air
- Auto-weight sense and auto-balancing
- Unparalleled safety
- Fast, responsive and precise
- **Low carbon footprint**

STANDARD MODELS		LIFTRONIC AIR						
		LA80		LA160		LA250		LA400
Gross capacity (including lifting tool)	kg	80	110*	160	210*	250	310*	400**
Vertical stroke	mm	1752	1752	1716	1716	1451	1451	1167
Arm length	mm	2700	2700	2700	2700	2605	2605	2000
Offset handling: max. distance from the lifting tool Z axis	mm	300	-	300	-	500	-	400
Uncovered area	mm	907	907	935	935	900	900	-
Rotation around column axis	degrees	360°						
Rotation around tool axis	degrees	550°						
Air pressure min.	bar	6.5						
Power supply	V-AC Hz	115/230 50/60						
Power consumption max	VA	100						
Enclosure protection	IP	54						

\*\*Available in 5 versions with load capacities up to 570 kg.

\*With counterweights.





# PN Series

## Traditional Industrial Manipulators

PN Series are traditional industrial manipulators featuring **full pneumatic operation**.

**It is suitable for handling offset and/or very heavy loads.**

PN units can be supplied either column, ceiling or overhead rail mounted.

### Main features

- **Reliable**

Continuous product development using standard modules and components for improved safety and efficiency.

- **Safe**

Equipped with safety devices that maintain the grip on the load, even in the event of a total air loss. It is not possible to release the load when it is fully supported by the machine. When the control handle is released, a full set of brakes lock the machine and prevent further movement

- **Versatile**

It can be equipped with a wide range of bespoke tools operated pneumatically by grip or vacuum. Simple mechanical tools can also be used.

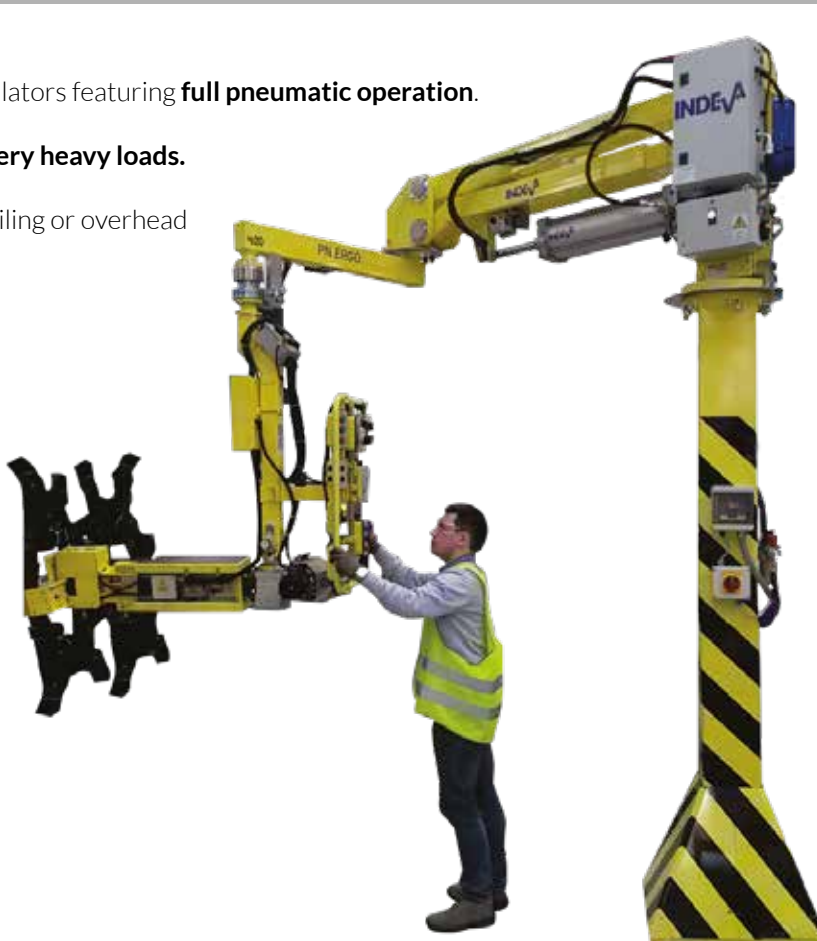

STANDARD MODELS		PN ERGO						
		PN80		PN160		PN250		PN400
Gross capacity (including lifting tool)	kg	80	110*	160	210*	250	310*	400**
Vertical stroke	mm	1752	1752	1716	1716	1451	1451	1167
Arm length	mm	2700	2700	2700	2700	2605	2605	2000
Offset handling: max. distance from the lifting tool Z axis	mm	300	-	400	-	500	-	400
Uncovered area	mm	907	907	935	935	900	900	-
Rotation around column axis	degrees	continuous						
Rotation around tool axis	degrees	standard: 550 optional: continuous						
Air pressure min.	bar	6.5						

\*\*Available in 5 versions with load capacities up to 570 kg.

\*With counterweights.





# PN Series



PN Ergo



PN Compatto



PN Flex



PN Zip

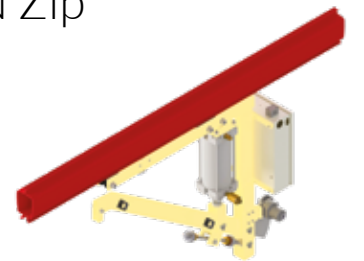

# Industry fields

- AGRICULTURE
- AEROSPACE
- AUTOMOTIVE
- BATHROOM AND TOILETWARE
- CERAMIC
- CHEMICALS/ PHARMACEUTICALS
- ELECTRO-MECHANICAL
- ELECTRONICS
- FOOD/DRINK/TOBACCO
- FOUNDRY
- FURNITURE
- GLASS
- HOUSEHOLD ELECTRIC APPLIANCES
- MECHANICS
- METAL WIRES
- MOTORCYCLES
- PAPER PRODUCTION
- RUBBER/PLASTICS
- TEXTILE
- TYRES

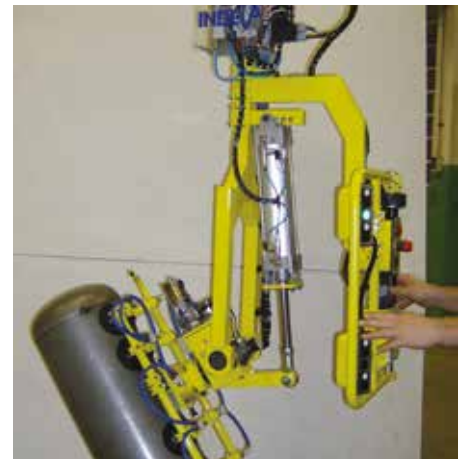
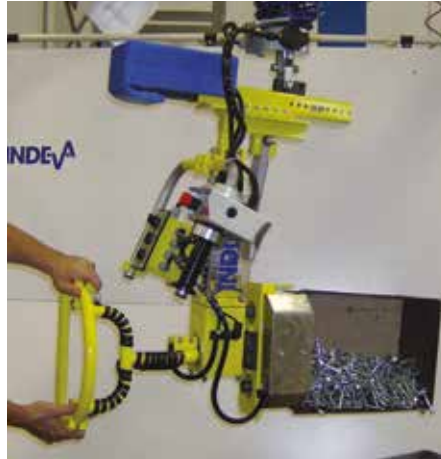





**Scaglia INDEVA**  
Italy

Scaglia INDEVA SpA  
Via Marconi, 42  
24012 Val Brembilla (BG)  
Tel. +39 0345 59 411  
info@it.indevagroup.com  
www.indevagroup.it



**Scaglia INDEVA**  
Germany

Scaglia INDEVA GmbH  
Esslinger Str. 26  
D-73249 Wernau  
Tel. +49 (0) 7153 55049-0  
info@de.indevagroup.com  
www.indevagroup.de



**Scaglia INDEVA**  
France

Scaglia INDEVA SARL  
215 Rue Henry Barbusse  
95100 Argenteuil  
Tel.: +33 (0) 1 39 19 30 30  
info@fr.indevagroup.com  
www.indevagroup.fr



**Scaglia INDEVA**  
United Kingdom

Scaglia INDEVA Ltd  
Coney Green Business Centre, Clay Cross  
Chesterfield, Derbyshire S45 9JW  
Tel. +44 (0) 1246 25 23 33  
info@uk.indevagroup.com  
www.indevagroup.co.uk



**Scaglia INDEVA**  
Sweden

SCAGLIA INDEVA Nordic AB  
Torbornavägen 24  
253 68 Helsingborg  
Tel. +46 (0) 424002460  
info@se.indevagroup.com  
www.indevagroup.se



**Scaglia INDEVA**  
United States

Scaglia INDEVA Inc.  
3630 Green Park Circle  
Charlotte, NC 28217  
Tel. +1 704 357 8811  
info@us.indevagroup.com  
www.indevagroup.com



**SIT INDEVA**  
P. R. of China

SIT INDEVA (Shanghai) Ltd  
Shanghai Nanhui Industrial Park  
#2 Building, No 269 YuanZhong Rd. 201300  
Tel. +86 (21) 5108 2206 - 107  
info@cn.indevagroup.com  
www.indevagroup.cn